

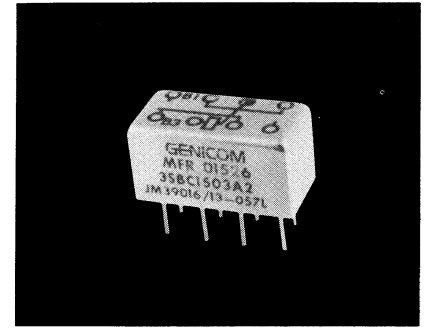

# 150 Grid-space Micro-miniature Relays



A

## Type 3SBC (2PDT) Standard

135mW 2PDT  
50 mW (Form AB) 1 PNC — 1 PNO

### Features

- Low profile... only 0.32 inch high
- Internal diode for coil transient suppression and transistor driven models available
- MIL-R-39016/13
- RF designs available

### Description

The 150 Grid-space relay — only 0.32 inches high — save space in electronic packaging. The pin spacing allows you to insert the relay with no intermediate pin spreaders as well as meet applicable military specifications.

## Other Specifications

### Contact Ratings:

DC resistive — 2 amps at 28 volts (50,000 operations)  
1 Amp@ 28V (100,000 operations)  
DC inductive — 0.5 amps at 28 volts, 200 mH  
AC resistive — 0.5 amps at 115 volts  
AC - 0.125 amps at 115 volts (case grounded)  
Low-level — 50  $\mu$ A at 50 mV  
Peak AC or DC

### Contact Resistance:

0.050 ohms max.; 0.150 ohm after life test

### Life:

100,000 operations at rated loads listed;  
1,000,000 operations at low-level loads

### Operate Time:

4 ms max.

### Release Time:

4 ms max.

### Bounce:

1.5 millisecond

### Dielectric Strength:

500 volts rms at sea level  
350 volts rms at 70,000 feet and above

### Insulation Resistance:

1,000 megohms minimum over temperature range

### Vibration:

30G, to 3000 Hz

### Shock:

100G at 11 ms

### Temperature:

-65C to +125C

See page 15 for Mounting Forms, Terminals and Circuit Diagrams.

F

Coil Table Type 3SBC (All Values DC)\*2PDT, 135 mW Sensitivity: (Code 1)

Coil Code Letter	Coil Resistance @ 25C (ohms)	Voltage Calibrated, Code 5				Current Calibrated, Code 6			
		Suggested Source Volts†	Max. Operate Volts @ 25C	Release Voltage Range @ 25C		Max. Continuous Current @ 125C (mA)	Max. Operate Current @ 25C (mA)	Release Current Range @ 25C (mA)	
				Max.	Min.			Max.	Min.
A	44 $\pm$ 10%	3.5-6.2	2.4	1.45	0.26	87.0	54.5	32.7	6.00
B	56 $\pm$ 10%	4.0-7.0	2.7	1.6	0.3	77.0	48.3	28.6	5.30
D	140 $\pm$ 10%	6.4-12.0	4.4	2.6	0.5	50.3	31.4	18.5	3.60
E	210 $\pm$ 10%	8.0-16.0	5.4	3.2	0.6	40.0	25.7	15.4	2.80
L	650 $\pm$ 10%	13.6-24.0	9.5	5.6	1.0	22.9	14.3	8.6	1.54
K	1350 $\pm$ 10%	20.0-35.0	13.5	8.1	1.5	15.5	10.0	6.0	1.10
N	2245 $\pm$ 10%	26.0-46.0	17.1	10.5	1.9	12.0	7.6	4.7	0.84

E

F

Coil-Data (All Values DC)\* Type 3SBC Form AB 50 mW Sensitivity non mil spec: (Code 2)

Coil Code Letter	Coil Resistance @ 25C (ohms)	Voltage Calibrated, Code 5				Current Calibrated, Code 6			
		Suggested Source Volts†	Max. Operate Volts @ 25C	Release Voltage Range @ 25C		Max. Continuous Current @ 125C (mA)	Max. Operate Current @ 25C (mA)	Release Current Range @ 25C (mA)	
				Max.	Min.			Max.	Min.
B	56 $\pm$ 10%	2.6-7.0	1.8	1.1	0.16	46.5	29.1	18.2	3.30
C	85 $\pm$ 10%	3.3-9.5	2.3	1.4	0.20	38.7	24.2	15.1	2.70
D	140 $\pm$ 10%	4.3-12.0	2.9	1.8	0.27	30.4	19.0	11.9	2.10
E	210 $\pm$ 10%	5.3-14.0	3.6	2.2	0.33	24.8	15.5	9.7	1.75
F	360 $\pm$ 10%	6.7-19.0	4.5	2.8	0.41	18.9	11.8	7.2	1.30
G	510 $\pm$ 10%	8.2-23.0	5.6	3.5	0.51	15.8	9.9	6.2	1.10
H	775 $\pm$ 10%	10.0-26.0	6.8	4.2	0.62	12.8	8.0	5.0	0.90
K	1350 $\pm$ 10%	13.2-35.0	9.0	5.6	0.82	9.8	6.1	3.8	0.68
N	2245 $\pm$ 10%	16.8-46.0	11.4	7.1	1.00	7.4	4.6	2.9	0.52

E

\*Values listed are factory test and inspection data. User should allow for meter variations.

†At nominal resistance plus 10%.

‡ Applicable over the operating temperature range in circulating air.

# 150 Grid-space Hybrid Micro-miniature Relays

## Single Diode, Dual Diode

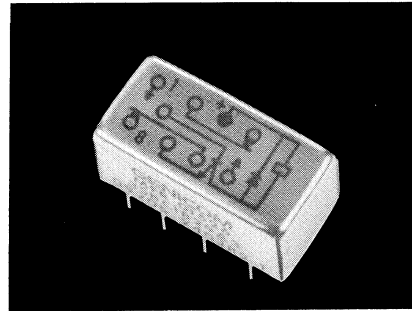

### Type 3SBC (2PDT) 135 mW

#### Features

- Low profile... only 0.32 inch high
- 50 milliwatt forms available
- MIL-R-39016/37
- MIL-R-39016/38
- RF designs available

#### Description

The hybrid 150 Grid-space relay — only 0.32 inches high — saves space in electronic packaging. The pin spacing allows you to insert the relay with no intermediate pin spreader.

#### Other Specifications

##### Contact Ratings:

DC resistive — 2 amps at 28 volts (50,000 operations)  
1 Amp@ 28V (100,000 operations)  
DC inductive — 0.5 amps at 28 volts, 200 mH  
AC resistive — 0.5 amps at 115 volts  
AC - 0.125 amps at 115 volts (case grounded)  
Low-level — 50  $\mu$ A at 50 mV  
Peak AC or DC

##### Contact Resistance:

0.050 ohms max.; 0.150 ohm after life test

##### Life:

100,000 operations at rated loads listed;  
1,000,000 operations at low-level loads.

##### Operate Time:

4 ms max.

##### Release Time:

6 ms max.

##### Bounce:

1.5 millisecond

##### Dielectric Strength: Note (1)

500 volts rms at sea level  
350 volts rms at 70,000 feet and above

##### Insulation Resistance: Note (1)

1,000 megohms minimum over temperature range

##### Vibration:

30G, to 3000 Hz

##### Shock:

100G at 11 ms

##### Temperature:

-65C to +125C

### Semiconductor Characteristics at 25C

#### DIODE

Max. Negative Transient: 1.0 volt  
Breakdown voltage: 100VDC @ 10 microamps  
Max. Leakage Current: 1 micro amp @ 50 VDC

See page 15 for Mounting Forms, Terminals and Circuit Diagrams.

#### Coil Table Single Diode (All Values DC)\*(2DPT), 135 mW Sensitivity: (Code 5)

Coil Code Letter	Coil Resistance @ 25C (ohms)	Voltage Calibrated, Code 5				Current Calibrated, Code 6			
		Suggested Source Volts†	Max. Operate Volts @ 25C	Release Voltage Range @ 25C		Max. Continuous Current @ 125C (mA)	Max. Operate Current @ 25C (mA)	Release Current Range @ 25C (mA)	
				Max.	Min.			Max.	Min.
A	44 ± 10%	3.5- 6.2	2.4	1.45	0.26	87.0	54.5	32.7	6.00
B	56 ± 10%	4.0- 7.0	2.7	1.6	0.3	77.0	48.3	28.6	5.30
D	140 ± 10%	6.4-12.0	4.4	2.6	0.5	50.3	31.4	18.5	3.60
E	210 ± 10%	8.0-16.0	5.4	3.2	0.6	40.0	25.7	15.4	2.80
L	650 ± 10%	13.6-24.0	9.5	5.6	1.0	22.9	14.3	8.6	1.54
K	1350 ± 10%	20.0-35.0	13.5	8.1	1.5	15.5	10.0	6.0	1.10
N	2245 ± 10%	26.0-46.0	17.1	10.5	1.9	12.0	7.6	4.7	0.84

#### Coil Table Dual Diode (All Values DC)\*(2DPT), 135 mW Sensitivity: (Code 6)

Coil Code Letter	Coil Resistance @ 25C (ohms)	Suggested Source Volts†	Max. Operate Volts @ 25C	Max.	Min.	Max. Continuous Current @ 125C (mA)	Max. Operate Current @ 25C (mA)	Max.	Min.
A	44 ± 10%	3.9- 7.0	3.4	2.0	0.37	98.2	77.3	45.5	8.4
B	56 ± 10%	4.6- 8.0	3.7	2.2	0.41	89.8	66.1	39.3	7.1
D	140 ± 10%	7.8-12.0	5.4	3.2	0.6	52.4	38.6	22.9	4.3
E	210 ± 10%	9.3-16.0	6.4	3.8	0.7	41.4	30.5	18.1	3.3
L	650 ± 10%	15.0-24.0	10.5	6.2	1.1	23.6	16.2	9.5	1.7
K	1350 ± 10%	21.0-35.0	14.5	8.7	1.6	16.0	10.7	6.4	1.2
N	2245 ± 10%	27.0-46.0	18.1	10.9	2.0	12.1	8.1	4.9	0.9

## ORDERING INSTRUCTIONS

**Example:** The relay selected in the example is a FORM AB 150-grid relay, current calibrated, end bracket mounting with 0.13-inch solder hook header, 210 ohms coil resistance, and 50 mW sensitivity. By choosing the proper code for each of these relay characteristics, the

catalog number is 3SBC6131E2. The letter R following sensitivity code indicates relay received 5000 operation miss-test. Ex. 3SBC6131E2R.

**Note:** Relays specified by catalog numbers (per above directions) are general-use items controlled by catalog specifications. Relays to be controlled by customer drawings — or relays having requirements not covered in this publication — will be assigned special catalog numbers upon request.

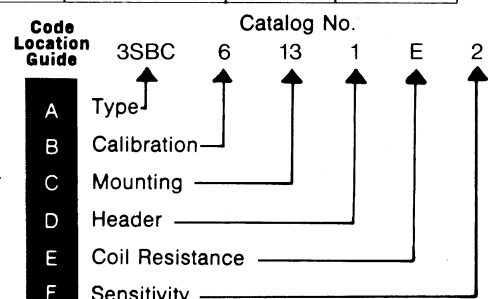



# 150 Grid-space Long-life Micro-miniature Relays

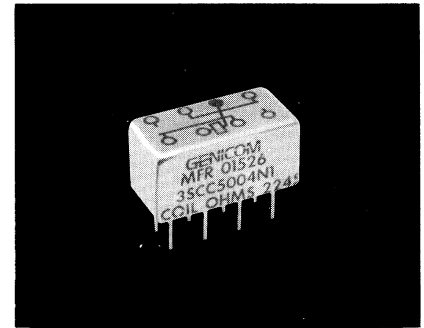

A

## Type 3SCC (2PDT) 170 mW

### Features

- 100,000,000 operations low-level signal loads
- RF designs available
- Low profile — .320 height
- Hermetic seal
- High reliability
- Performance tested

### Description

The .150 Grid relay, the smallest (.320 inches high) 2 Amp Rated relay available in commercial and military qualified models, is now available in the long life version. Capable of over 100,000,000 mechanical operations at low level and signal load, the .150 Grid relay provides the simplicity of relays for circuit design, the low circuit resistance of precious metal

contact systems, and the long life processing that has made CII relays the standard for quality and reliability.

### Other Specifications

#### Contact Ratings:

DC resistive — 2 amps at 28 volts (50,000 operations)  
 1 Amp@ 28V (100,000 operations)  
 DC inductive — 0.5 amps at 28 volts, 200 mH  
 AC resistive — 0.5 amps at 115 volts  
 AC - 0.125 amps at 115 volts (case grounded)  
 Low-level — 50  $\mu$ A at 50 mV  
 Peak AC or DC

#### Contact Resistance:

0.050 ohm max.; 0.150 ohms after life test

#### Life:

100,000 operations at rated loads listed;  
 100,000,000 operations at low-level loads

#### Operate Time:

4 ms max.

**Release Time:**  
4 ms max.

**Bounce:**  
1.5 millisecond

**Dielectric Strength:**  
500 volts rms at sea level  
350 volts rms at 70,000 feet and above

**Insulation Resistance:**  
1,000 megohms minimum over temperature range

**Vibration:**  
30G, to 3000 Hz

**Shock:**  
100G at 11 ms

**Temperature:**  
- 40C to + 125C

See page 15 for Mounting Forms, Terminals and Circuit Diagrams.

F

B

E

### Coil Table Type 3SCC (All Values DC)\* 2 PDT Relay — 170mW Sensitivity: (Code 1)

Coil Code Letter	Coil Resistance @ 25C (ohms)	Voltage Calibrated, Code 5				Current Calibrated, Code 6			
		Suggested Source Volts†	Max. Operate Volts @25C	Release Voltage Range @ 25C		Max. Continuous Current @ 125C (mA)	Max. Operate Current @ 25C (mA)	Release Current Range @ 25C (mA)	
				Max.	Min.			Max.	Min.
A	44 ± 10%	3.5- 6.2	2.7	1.45	0.26	87.0	61.4	32.7	6.00
B	56 ± 10%	4.0- 7.0	3.1	1.6	0.3	77.0	55.4	28.6	5.30
D	140 ± 10%	6.4-12.0	4.9	2.6	0.5	50.3	35.0	18.5	3.60
E	210 ± 10%	8.0-16.0	5.9	3.2	0.6	40.0	28.0	15.4	2.80
L	650 ± 10%	13.6-24.0	10.5	5.6	1.0	22.9	16.2	8.6	1.54
K	1350 ± 10%	20.0-35.0	15.1	8.1	1.5	15.5	11.2	6.0	1.10
N	2245 ± 10%	26.0-46.0	19.5	10.5	1.9	12.0	8.7	4.7	0.84

\* Values listed are factory test and inspection data. User should allow for meter variations.

† Applicable over the operating temperature range in circulating air.

## ORDERING INSTRUCTIONS

**Example:** The relay selected in the example is a FORM AB 150-grid relay, current calibrated, end bracket mounting with 0.13-inch solder hook header, 210 ohms coil resistance, and 50 mW sensitivity. By choosing the proper code for each of these relay characteristics, the

catalog number is 3SBC6131E2. The letter R following sensitivity code indicates relay received 5000 operation miss-test. Ex. 3SBC6131E2R.

**Note:** Relays specified by catalog numbers (per above directions) are general-use items controlled by catalog specifications. Relays to be controlled by customer drawings — or relays having requirements not covered in this publication — will be assigned special catalog numbers upon request.

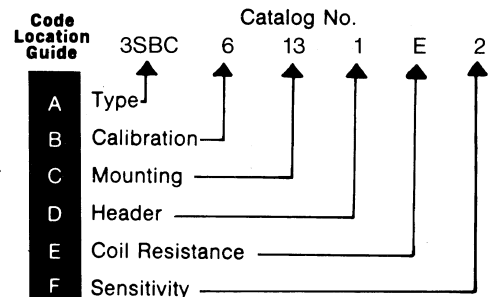

# Mounting Forms (3SBC, 3SCC)

(Vibration note with each form is acceleration from 55 to 3000 Hz)

All dimensions in inches

TOLERANCES (Unless otherwise specified)	
Hundredths	± 0.020
Thousandths	± 0.005

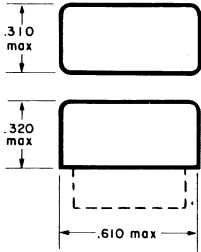

No Mount

Mounting Code	Vibration
00	30g

\*Assumes relay held securely by potting or other means

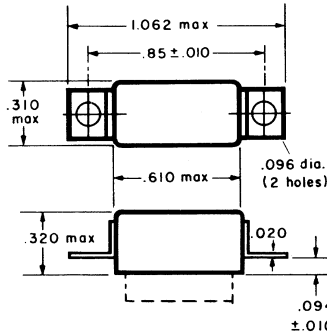

End Bracket

Mounting Code	Vibration
13	30g

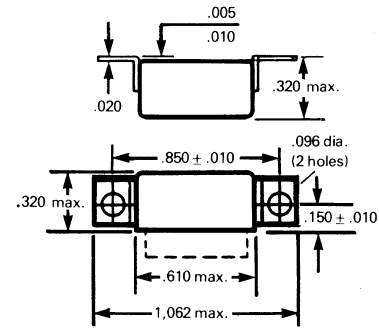

Side Bracket

Mounting Code	Vibration
25	30g

## HEADER AND CONNECTION DIAGRAMS

### HEADER TYPES

TYPE	Z DIMENSION	HEADER CODE
Solder hook	0.13	1
Straight pin	0.12	8
Straight pin	0.19	4
Straight pin	0.25	5

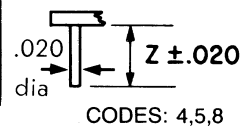
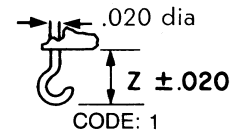

CODE 1, 5, & 6

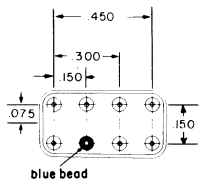

CODE 2

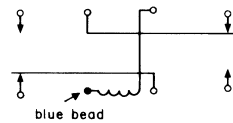
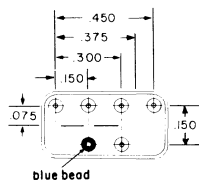

CODE 1

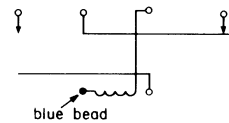

CODE 2

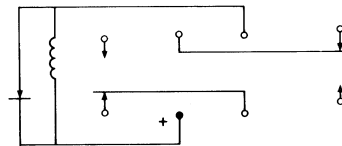

CODE 5  
SINGLE DIODE

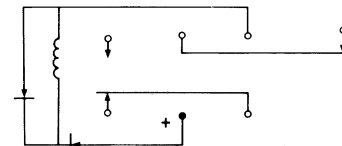

CODE 6  
DUAL DIODE

## TERMINAL VIEW

C

D

F